

# Spa Owner's Manual

## 240 Volt 2 Speed Pump

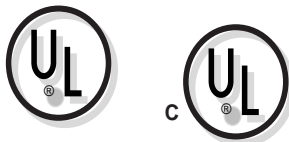

**USE THIS SERIAL NUMBER WHEN CALLING  
FOR TECHNICAL ASSISTANCE  
(866)245-3387**



**Part#377447**

# Special Notice

*Your spa is required by National Electric Code (NEC) to have a ground fault circuit interrupter (GFCI) installed in the electric wiring circuit supplying electricity to your spa. GFCI devices are very sensitive components that if installed incorrectly, can nuisance trip & cause component damage that is not covered by the Manufacturers Warranty.*

*To minimize the chance of nuisance tripping, insist that a **Licensed Electrician** test your installation with a Megohm tester or a dielectric tester before completing the installation. This will greatly reduce the chance of a problem with your spa installation.*

**Under no circumstances should a spa ever be operated without GFCI protection!**

# Table of Contents

Important Safety .....	4
Spa Location .....	6
Spa Equipment System .....	7
Topside Control & Operating Instructions .....	8
Error Messages .....	10
Control System Features .....	12
Installation Instructions & Filter Maintenance.....	14
Start Up Steps .....	17
Winterizing the Spa .....	18
Spa Maintenance .....	19
Water Quality Maintenance .....	20
Spa Troubleshooting Guide .....	21
Wiring Diagrams & GFCI Installation.....	23

## **IMPORTANT!**

*Take This Time to Register Your Spa.*

To order parts or accessories, please call our parts and accessories sales department at 800-393-3399 .

## **Owner's Record**

Date Purchased \_\_\_\_\_

Purchased From \_\_\_\_\_

Installed By \_\_\_\_\_ Date \_\_\_\_\_

Spa Serial Number \_\_\_\_\_ Model Number \_\_\_\_\_

# Important Safety Instructions

The following instructions are required by Underwriters Laboratories (UL) to be printed as a condition of their listing this product. They contain important safety information that we strongly urge you to read and apply. When installing and using this electrical equipment, basic safety precautions should always be followed, including the following:

## Read and Follow All Instructions

1. **Warning:**

**Risk of injury:** Do not permit children to use this product unless they are closely supervised at all times.

2. **Danger:**

**Risk of Injury:** A wire connector is provided on this unit to connect a minimum No. 8 AWG solid copper conductor between the unit and any metal equipment, metal enclosures of electrical equipment, metal water pipe, or conduit, if that item is located within 5 feet (1.5 Meters) of the unit.

**Danger:**

3. **Risk of Accidental Drowning:** Extreme caution must be exercised to prevent unauthorized access by children. To avoid accidents, ensure that children cannot use this spa unless they are supervised at all times.

**Danger:**

4. **Risk of Injury:** The suction fittings in this spa are sized to match the specific water flow created by the pump. Should the need arise to replace the suction fittings or the pump, be sure that the same authorized replacement part is used.

**Danger:**

5. **Risk of Electric Shock:** The spa may be Installed within 5 feet (1.5 Meters) of metal surfaces if each metal surface is permanently connected by a minimum No. 8 AWG solid copper conductor to the wire connector on the spa terminal box that is provided for this purpose.

**Danger:**

6. **Risk of Electric Shock:** Do not permit any electrical appliance, such as a light, telephone, radio or television within 5 feet (1.5 Meters) of the spa.

**Warning:**

7. **Risk of injury:** The water in a spa should never exceed 104°F (40°C). Water temperatures between 100°F (38°C) and 104°F (40°C) are considered safe for a healthy adult. Lower temperatures are recommended for young children when spa use exceeds 10 minutes. Since excessive water temperatures have a high potential for causing fetal damage during early pregnancy, pregnant or possibly pregnant women should limit water temperatures to 100°F (38°C) and below. **Before entering a spa, the user should measure the water temperature with an accurate thermometer.**

## Safety Instructions (Continued)

8. **Danger:**

The use of alcohol, drugs or medication before or during spa use may lead to unconsciousness with the possibility of drowning. Persons suffering from obesity, medical history of heart disease, low/high blood pressure, circulatory system problems or diabetes, should consult a physician before using a spa. Persons using medication should consult a physician before using a spa because some medications induce drowsiness while others may affect heart rate, blood pressure and circulation.

9. **Danger:**

Prolonged immersion in hot water may induce hyperthermia. The causes and effects of hyperthermia may be described as follows: Hyperthermia occurs when the internal temperature of the body reaches a level several degrees above the normal body temperature of 98.6°F(37°C).

The effects of hyperthermia include:

- a. Failure to perceive heat.
- b. Failure to recognize the need to exit the spa or hot tub.
- c. Unawareness of potential hazards.
- d. Fetal injury in pregnant women.
- e. Physical inability to exit the spa or hot tub.
- f. Unconsciousness resulting in the danger of drowning.

*Warning - The use of alcohol, drugs or medication can greatly increase the risk of fatal hyperthermia.*

**SAVE THESE INSTRUCTIONS**

# Spa Location

The location of your spa is very important in order to achieve maximum enjoyment. Please consider the following:

## Outdoor Location

- 1 .Consider local city codes pertaining to fencing, enclosures, walls, electrical and plumbing. You will need to ensure that your spa is within adequate distance from power lines, both above ground and underground. Your spa will also need to be childproof (covered and of adequate height). Gates or doors must be self-closing and or self-locking.
- 2 .Locate the spa with an awareness to sunlight exposure, views, access, lot lines, lighting, wind direction, shielding, septic tanks, plants and trees (chemicals in the spa water splashed from your spa may damage plant life).
- 3 .Provide adequate drainage away from the spa equipment.
- 4 .Place the spa on a firm, level surface able to support a minimum of 90 pounds (33.5 Kg) square foot without shifting.
- 5 .It is the responsibility of the spa owner to provide clear working access on all sides of the spa once it is set in place. This will ensure ease of access for repairs should they become necessary. If a clear access to all sides of the spa is not provided, additional repair costs could be incurred.

## Deck Location

**Jacuzzi Spa Division may make product modifications and enhancements. Therefore, specifications may change without notice. Dimensions are approximate and for reference only.**

### Caution:

Always measure entire spa for exact dimensions before designing its foundational support and or decking. When designing a foundational support, always account for the following load factors:

- 1.Filled spa weight, plus (+)
- 2.Combined occupant weight (+)
- 3.Weight of support decking

The technical data given in this publication is for reference only. It implies no warranty of any kind. During the normal use of the spa, water will escape the spa vessel. Never place the spa on or over any material that may be damaged by this water or the chemicals within the water. Keep damageable materials far enough away from the spa to avoid water damage. Furniture, wall coverings etc., within the room in which the spa is to be located must be able to withstand the effects of high humidity. Adequate ventilation must be provided, whether through cross ventilation or a dehumidifier, to prevent damage to the structure. In cold climates, double glazing windows will help reduce condensation.

# Spa Equipment System

## Two Speed Pump

The control system includes a two speed pump that provides hydrotherapy jet action while operating in high speed. The same pump works in low speed along with the heater and the ozone generator (if equipped) to filter and sanitize the water (please see page 19 for sanitizing instructions).

## Single Speed Pump

Your spa features a single speed pump (if equipped) for hydrotherapy jet action. This pump is controlled by the  button on the topside control. Follow the instructions under TOPSIDE CONTROL OPERATING INSTRUCTIONS (page 8).

## Heater

Your spa is equipped with an electrical heater. By setting your thermostat to the desired temperature, your heater along with the low speed pump will automatically turn on and off to maintain the set temperature. This is not only convenient, it is also energy efficient. The spa will maintain the water temperature as required and does not depend on the filtration cycle to heat.

## Digital Topside Control

Your spa is equipped with a Digital Topside Control located on the top of the spa. The Topside Control provides all control functions of the spa equipment (pumps, light, heater). For more details follow the TOPSIDE CONTROL OPERATING INSTRUCTIONS (page 8) and CONTROL FEATURES (page 12).



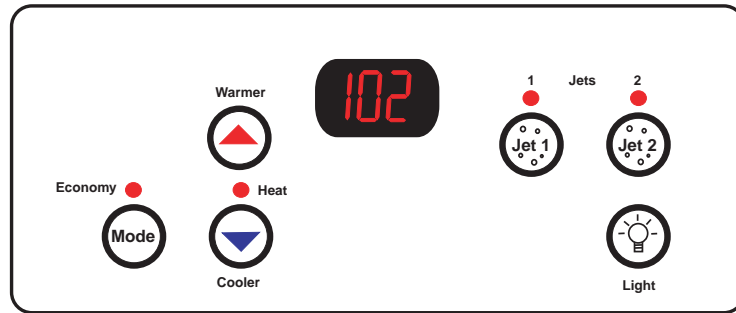

## Ozone Generator

Ozone generator (if equipped) injects ozone into the spa water during the (low speed) filtration cycle. Ozone is injected into the water to supplement chemical sanitizers, kill bacteria, and oxidize organisms. The ozone generator will help to reduce the amount of chemicals needed to keep the spa sanitary and clean. Anytime the jet pump (high speed) is turned on when the spa is in the filtration cycle, the ozone generator will turn off and will remain off until the next filtration cycle.



# TOPSIDE CONTROL OPERATING INSTRUCTIONS





## Temperature Controls Buttons

When either of the   buttons is pressed once, the display will show the temperature that has been set. Each time either of the   buttons is pressed again, the set temperature will increase or decrease in increments of 1°F depending on which button is pressed. After 3 seconds, the display will automatically show the current spa water temperature.



## Jets 1 Button

The control panel button designated  activates high speed pump when pressed once. When the  button is manually pressed again, the low speed pump will be activated. When the pump is in operation, the LED  is illuminated. (Flashes in low speed)



### Note:

After the  button on the topside control is used, the spa will automatically shut down within 20 minutes of use. After the 20 minutes of use has expired, the jets may be restarted by pressing the  button again.





## Jets 2 Button (if equipped)

The topside control button designated  activates pump # 2 (high speed single pump only) when pressed. Pump 2, when manually pressed, has a twenty minute time-out. If the  button is pressed again prior to completion of the 20 minute time-out, the pump 2 will be deactivated and the time-out will reset. When pump 2 is in operation, the “JET 2” LED is illuminated.

## Light Button

The control panel button designated  activates the spa light when pressed. The light has a forty minute time-out. If the  button is pressed again prior to the 40 minute time-out, the light will be deactivated.

## Mode Button

The button designated  switches the system between Standard and Economy modes. In Standard mode, the spa will be heated automatically to the set temperature and maintain that temperature. In Economy mode, the heater is disabled, but the  and  buttons can be activated. In Economy mode, the LED light above the  button on the topside control will be lit.



# TOPSIDE CONTROL OPERATING INSTRUCTIONS(Continued)

## **Air Jets button (if equipped)**

The topside control button designated “AIR” activates the air blower when pressed. The air blower, when the “Air” button is manually pressed, has a 20 minute time-out. If the “AIR” button is pressed again prior to the completion of the 20 minute time-out, the air blower will be deactivated and the time-out will reset. When the air blower is in operation, the LED “AIR” is illuminated.

## **Changing The Filter Cycles/Water Filtration**

Proper filtration is an important key to maintaining the clarity of your spa’s water. The filter system is designed to remove debris and particles from the water when the water is circulating.

The system has seven programmable filtration cycles. The default from the factory is 2 hours on 10 hours off. To enter the filter cycle change mode, the user must press and hold the  button for five seconds until one of the following messages is shown on the LED (topside control) read-out:

(2-9) (On 2hours/Off 10hours); displays 9 instead of 10 only “3” digits on the readout.

(2-6) (On 2hours/Off 6hours);



(2-4) (On 2hours/Off 4hours);

(2-2) (On 2hours/Off 2hours);

(4-2) (On 4hours/Off 2hours);

(6-2) (On 6hours/Off 2hours);

On (On All the time); Pump runs continuously 24 hours a day on low speed. Used for extreme cold weather.

After entering the filter cycle change mode (see above), the user presses the   buttons to select the desired filter setting. The system display will return to normal after five seconds if the buttons have not been pressed.

## **Note:**

During a filter cycle, the  flashes on the topside control. When either the single speed pump or the blower (if equipped) is turned on during a filter cycle, the filtration cycle will stop and will resume on the next filtration cycle.

# Error Messages

The control system is a self-diagnostic system. The system will automatically display the error messages in the topside control window, if a problem is detected.

## **HtS High Temp Sensor:**

The control system checks the heating components and temperature sensor for errors. If a temperature sensor is open or an error is detected, the topside control will display the code **HtS - current water temp - HtS**. The heater and the jet pump will shut down. The automatic reset will occur after the open sensor condition is fixed. If the temperature sensor is closed and an error is detected, the topside control will display the code **HtS - OHt - current water temp - HtS**. The entire system will be disabled and the spa will need to be manually reset after the shorted sensor condition is fixed. This must be repaired by a service technician if the problem persists.



## **tS Temp Sensor:**

The control system checks the water temperature sensor for errors. If a temperature sensor is open and an error is detected, the topside control will display the code **tS - 0 - tS**. The heater and the jet pump will shut down. The automatic reset will occur after the open sensor condition is fixed. If the temperature sensor is closed and an error is detected, the topside control will display the code **tS - 255 - Ht - OHt - tS**. The entire system will be disabled and a manual reset will be required after the shorted condition is fixed. This must be repaired by a service technician if the problem persists.

## **PS2:**

The system checks for an open pressure switch when the pump is off. If an error is detected, the topside control will display the code **PS2 - current water temp - PS2**. The heater will shut down. An automatic reset will occur if this condition is fixed. The pressure switch may be out of adjustment or the water level is too high. This must be repaired by a service technician if the problem persists.

## **PS1:**

The control system checks for a closed pressure switch with the low speed pump or high speed pump active. If an error is detected, the topside control will display **PS1 - current water temp - PS1**. The heater will be deactivated. An automatic reset will occur if this condition is fixed within 2 1/2 minutes. After 2 1/2 minutes the jets will shut down. The manual reset is required if this condition has existed more than 2 1/2 minutes. This error may be caused by a dirty filter. Remove and clean the filters before calling for service. For manual reset, push the   buttons simultaneously or turn the main power off and then back on. This must be repaired by a service technician if the problem persist.

## **dCP DC power:**

The system checks for DC power at the relay (master control relay). Error code **dCP** is displayed if an error is found. This message can appear after a power interruption or lightning. This must be repaired by a service technician if the problem persist.

# Error Messages ( Continued )



## **“FC” Freeze Condition**



The System checks the water temperature for a reading at or below 55°F(12°C). If an error is detected, the topside control will display the code **“FC”** This means a potential freeze condition has been detected (the spa temp is below 55°F(12°C). No action is required at this time, the system will automatically turn on the heater. In the Economy mode (ECO Mode) the heater will still work & will automatically bring the water temperature up to a safe temperature then shut down. When the water temperature in the spa is equal to or less than 50°F(10°C) the spa will turn on the high speed pump for 5 minutes, the heater is not active. Then the system will automatically start the heater and the low speed pump for 20 minutes. These cycles will be repeated until the spa reaches a safe temperature (above 55°F(12°C). The topside control will display **“FC” - current water temperature - “FC”**. This must be repaired by a service technician if the problem persists.

## **“Ht” High temperature condition.**

The control system checks the spa water for a temperature equal to or above 110°F(43°C). If the water temperature is equal to or above 110°F(43°C), The topside control will display the code **“Ht” - current water Temp - “Ht”**. All the Jets will shut down. This issue can be caused by outside air temperatures being too high in the summer time. Also excessive circulation cycle times in the summer can cause this error: i.e. resetting the high speed Jets continuously after each 20 minute shut down cycle. This must be repaired by a service technician if the problem persists.





## **“OHt” Overheating Condition / Watchdog.**

The system checks the spa water for temperature equal to or above 120°F(48°C) or the heater enclosure temperature that is equal to or above 125°F(51°C). If the spa water temperature is equal to or above 120°F(48°C) or the heater enclosure temperature is equal to or above 125°F(51°C), the topside control will flash **“OHt” - current Water Temp - “OHt”**. The **“OHt”** condition requires a manual reset either by pushing the   buttons simultaneously, or by turning the main power off and then back on. The heater hi-limit switch cannot reset until the heater enclosure temperature drops below 123°F(50°C) or the water temperature in the spa drops below 117°F(47°C). This must be repaired by a service technician if the problem persists.

**Note: For manual reset, push the   buttons simultaneously or turn the main power off and then back on.**

# Control System Features

## High Temperature Limit Protection

The high temperature limit protection will disable all relays when the spa water temperature is equal to or greater than 120°F(48°C). This condition will require manual reset by pushing the   buttons simultaneously, or by turning the power off and then back on. The high temperature limit protection cannot be reset until the spa water temperature drops below 117°F(47°C). The high limit protection disables all relays when the heater enclosure temperature reaches 125°F(51°C) or greater. The heater high limit cannot be reset until the heater enclosure temperature drops below 123°F(50°C). This condition requires a manual reset by pushing the   buttons simultaneously, or by turning the power off and then back on.





## Water Clean-out Cycle

To keep the water from becoming stagnant in the plumbing lines and in the spa, the JETS 2 (If equipped) will automatically turn on for 5 minutes of operation if the jet pump 2 has not been energized in any 48 hour period.

## Ozone Generator Operation

Preset from the factory the ozonator generator (if equipped) will operate during the filter cycles only.

## Temperature Set-Point Lockout (Temperature lock selector)

The temperature set-point lockout feature prevents unauthorized temperature adjustment of your spa water. The default factory setting of the set-point lockout is unlocked. To lock your temperature set-point, follow these instructions: Pressing and holding the   buttons, then press the  button. The light is now on and the thermostat is now locked. You can press  again and just the light will go off. To unlock the temperature set-point, repeat this same procedure.

## 240 VAC 30/50 Amp Setting (Heater Mode Selector)

When the spa is installed 240 VAC 50 Amp, then the power of the heater will operate with the high speed jets. The spa also has a 240 VAC 30 Amp configuration available. In the 240 VAC 30 Amp setting the heater will not operate with the high speed jets.

# ELECTRICAL SYSTEM

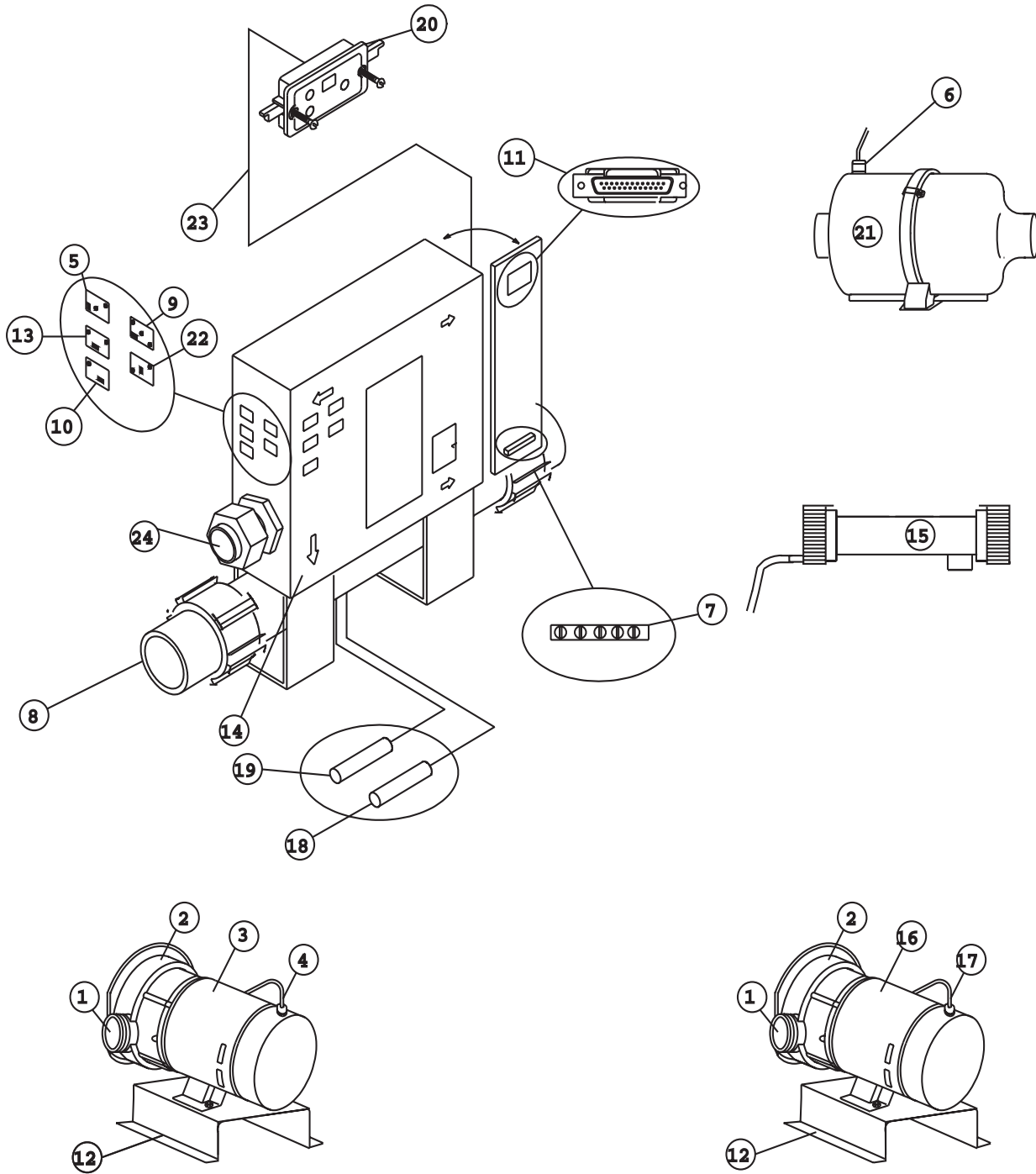

- 1. DISCHARGE UNION
- 2. PUMP WET END
- 3. 2 SPEED PUMP MOTOR
- 4. 2 SPEED PUMP CORD
- 5. BLOWER RECEPTACLE\*\*
- 6. BLOWER CORD\*\*
- 7. GROUNDING BAR
- 8. STAINLESS STEEL HEATER
- 9. 2 SPEED PUMP RECEPTACLE
- 10. LIGHT RECEPTACLE
- 11. SIDE CONTROL PORT CONNECTION
- 12. PUMP BASE
- 13. OZONATOR RECEPTACLE\*\*

- 14. ELECTRIC CONTROL PACK
  - 15. OZONATOR\*\*
  - 16. SINGLE SPEED PUMP MOTOR\*\*
  - 17. SINGLE SPEED PUMP CORD\*\*
  - 18. TEMPERATURE SENSOR (T.S.)
  - 19. HI-LIMIT SENSOR (H.T.S.)
  - 20. SIDE CONTROL
  - 21. BLOWER\*\*
  - 22. SINGLE SPEED PUMP RECEPTACLE\*\*
  - 23. SIDE CONTROL INTERCONNECT CABLE
  - 24. LIQUID TIGHT CONNECTOR 1"
- (\*\*IF EQUIPPED)

# INSTALLATION INSTRUCTIONS

Your spa, from the factory is designed for a 240 VAC 50 amp circuit. A qualified electrician should be called in to install the necessary wiring and equipment. Run the proper size wire in conduit from a dedicated circuit breaker (see chart below) to the equipment package. The circuit must contain a separate neutral wire and ground wire.

## Electrical Precautions Designed for 240VAC Only

Your spa, comes from the factory requiring a 240VAC, 50 amp AWG 6/4-wire, grounded type GFCI protected electrical service with copper conductors, and must be a separate circuit having no other appliances connected to that circuit. If you do not have this kind of circuit, a qualified electrician should be called in to install the necessary wiring and equipment.

## Electrical Precautions

1. Make sure the line cord does not lay across a walkway or in a heavily traveled area.
2. Do not use electrically connected devices, such as a TV, radio, telephones or cooking devices within 5 feet (1.524 meters) of the spa while the spa is being used. If electrical devices are used within 5-10 feet of the spa, they must be on a GFCI protected breaker/outlet.
3. **Caution:**  
All fixed metal objects located within 5 feet (1.524 meters) of the spa, such as fence posts, railing, door frames, gutters, etc., must be attached to the bonding bar on the outside of the electrical control pack using #8 solid copper wire.

## Electrical Service Connections

Line Service	Marking	Max. Circuit Capacity	GFCI
240 VAC	3 Wire # 6 + Ground	30/50 AMP	30/50 AMP

An illustration showing proper electrical connections for 240VAC service has been provided for you on a wiring diagram and instruction affixed to the back side of the electrical control box faceplate. Be sure to follow these and all other instructions carefully. Be sure that all connections are tight and spa is completely filled before switching the circuit breaker on.

**The spa must be connected to a circuit protected by a Ground Fault Circuit Interrupter (GFCI).**

**IF THE SPA IS WIRED INCORRECTLY, YOUR WARRANTY IS VOID.**

# Filter Maintenance

## Spa Maintenance Guide

### Filter Maintenance

It is important to maintain an unobstructed filtration system. Not only does this provide the spa with maximum performance for the hydrotherapy jets, but it allows for proper filtration. **We recommend that the filter(s) be cleaned once every two weeks.** Remove and soak the filters, to dissolve minerals submerge the filters in a solution of one part bleach and one part water for a period of 24 hours. Use a garden hose and squirt water into the center of the filter after the 24 hour soak. Rotate and flush the filter pleats. The water filtration system may become clogged with particles, debris or calcification that can reduce the water flow. The necessity of filter replacements depends on the use the spa receives and the mineral or body oil content. If calcification appears on the filter(s), replacement is necessary.

**Contact your local dealer or authorized service technician, or call the Customer Service Hotline at 1-800-393-3399 for replacement parts.**

**Warning: Do not run the spa without the filter(s) because debris may be pulled into the pump and cause damage which will void your warranty.**

SCREW-IN TYPE FILTER

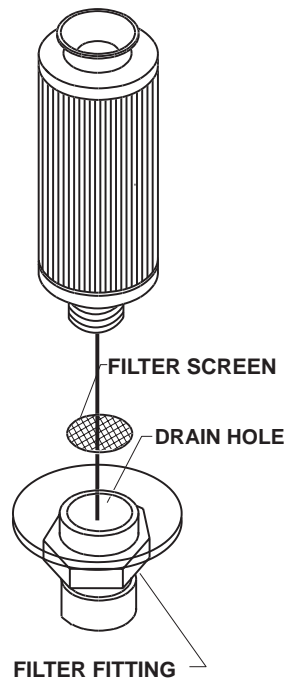

## For the Monarch spa only .

### Instructions for removing and installing cartridge filters in the Monarch spa.

Your spa is equipped with a cartridge filter located in the skimmer float assembly. Filtering is accomplished when the two speed pump, on either high or low speed, pulls water through the polyester mesh of the filter. As the water flows through the filter, suspended particles become trapped in its fibers. To ensure optimum performance, it is necessary to remove and clean the filter cartridge, usually once a week, depending on usage and water quality. To prevent debris from being pulled into the pump and possibly causing damage be sure to follow these directions carefully:

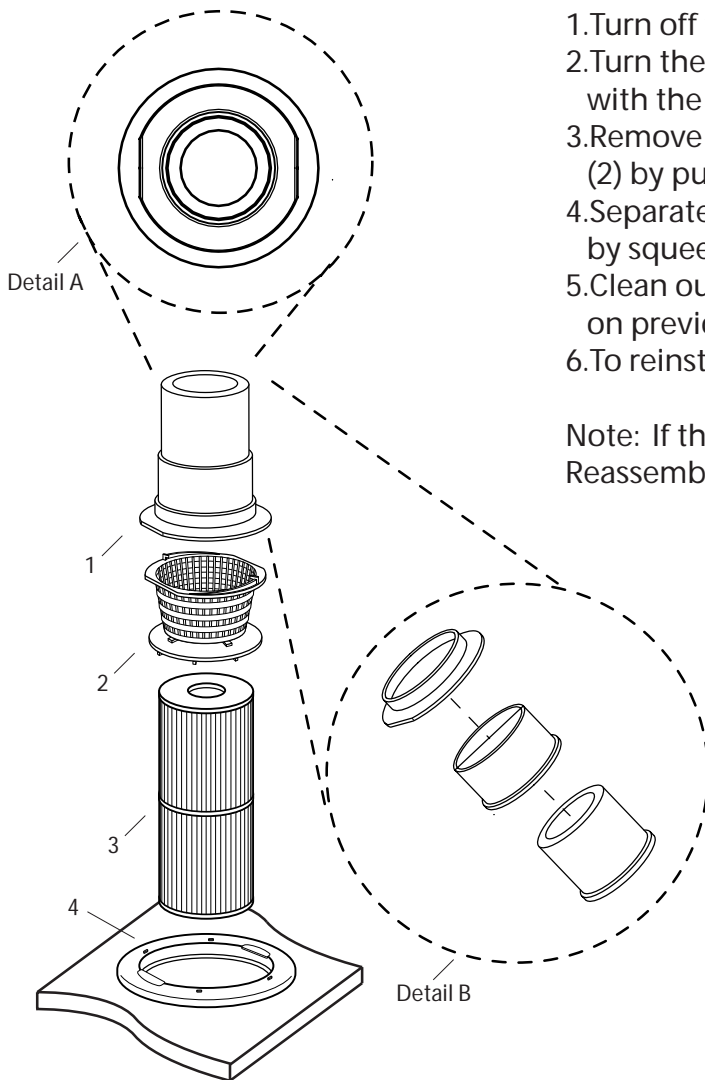

1. Turn off the spa's main power.
2. Turn the skimmer float assembly (1) to align the flat edges with the flat edges of the housing assembly (1) as seen in Detail A.
3. Remove the skimmer float assembly (1) and basket assembly (2) by pulling them straight out of the housing assembly (4).
4. Separate the basket assembly and the skimmer float assembly by squeezing the basket as directed on skimmer float assembly (1).
5. Clean out basket with running water, and clean filters as directed on previous page.
6. To reinstall, reverse steps 1 to 3.

Note: If the pieces of the skimmer float assembly (1) separate. Reassemble them as in Detail B.

- 1 - SKIMMER FLOAT ASSEMBLY
- 2 - BASKET ASSEMBLY
- 3 - CARTRIDGE FILTER
- 4 - HOUSING ASSEMBLY









Note: Do not operate the spa without the filter properly in place, as this voids the manufacturer's warranty. The average life expectancy of a spa filter cartridge is approximately two years with proper care and water quality maintenance. The replacement cartridge may be purchased by calling our parts dept. at (800)393-3399



# START UP STEPS



**Make sure you have read and understood all of the previous instructions in this manual. Make sure the spa has been installed correctly, including electrical wiring connections as specified in the wiring diagram.**

Prior to filling your spa with water and turning on the power, perform the following steps:

1. Install the filter(s).
2. Ensure that none of the water or air lines have slipped under the footwell area of the spa shell during shipment. Move them if they have.
3. Fill the spa with water to a level of 2" above the highest jet. The GFCI circuit breaker must be tested before use of the spa. Press the "Test" button on the breaker, the circuit breaker should go to the tripped position. Reset the GFCI and ensure it stays set.
4. Press the  button on your topside control. Within 15-30 seconds you should have water flowing from the hydrotherapy jets in the side of your spa. The  LED on the topside control should be lit. If after 30 seconds you do not have water flowing freely, turn off the pump (press  button once more), and open the drain valve to clear the system of air.
5. Try engaging the pump again and repeat the procedure. If after 3-4 tries you cannot get water to flow, contact a service technician for instructions on how to purge the air from your plumbing lines.
6. To turn the air controls on, twist the air controls located on the top of the spa to the "Open" position and verify that air starts coming out of the jets. To turn the air controls off, simply twist the air control to the "Closed" position and verify that air stops coming from the jets. This may take a few minutes.
7. Press the  button on your topside control and verify that:
  - 7.1. Rapid water movement stops and returns to the slower water movement (only the low speed pump running).
  - 7.2. The  LED on the topside control goes off.
8. Once the water is flowing freely from the hydrotherapy jets, you may adjust your temperature setting. From the factory, the setting is too low to come on by itself. It is recommended that you initially operate the spa between 95°F and 100°F and increase the temperature setting over a few days as you become accustomed to its effect. When the desired water temperature is reached, the heater will automatically maintain that temperature. When either of the   buttons is pressed and held, the "HEAT" LED will blink and the set temperature will increase or decrease, depending on which button is pressed. Release the button and after a short delay the window LED readout will automatically display the current spa water temperature.
9. If equipped with 2 pumps, repeat the same operations for the second pump, using the  button on the topside control and checking that the "JET 2" LED is on.

The spa (if equipped) with diverter valves enables you to alter the amount of water used for hydrotherapy message.

## START UP STEPS (continued)

11. Once the water is flowing freely from the jets, you may adjust your temperature setting to the desired temperature. From the factory, the setting is too low to activate the jets. It is recommended that you initially operate the spa between 95°F(35°C) and 100°F(37°C) and increase the temperature setting over a few days as you become accustomed to its effect. When the desired water temperature is reached, the heater will automatically maintain that temperature as your programmed setting. When either of the   buttons is pressed and held, the “HEAT” LED will blink and the set temperature will increase or decrease, depending on which button is pressed. Release the button and after a short delay the window LED readout will automatically display the current spa water temperature.
12. Install the insulated cover on the spa and allow the spa to heat for 24 hours to reach a stable temperature. After the spa has run for 24 hours, test the water temperature and adjust it to suit your particular needs.

## Winterizing the Spa

The two recommended ways to prepare your spa for winter are:

1. Continue to let the spa run through the winter.
2. Completely drain the spa and complete the following steps: Press the  button on the topside control, the “Economy” LED will illuminate and the heater is off.
  - Turn off the power source.
  - Remove the filters.
  - Drain the spa.
  - Completely drain the lines under the spa using a wet/dry vacuum at each of the jets.
  - Open the pump and heater unions and remove the water at these points.
  - Leave the unions open to allow trapped water to expand if it freezes.
  - Replace all panels and put the cover on the spa.

# Spa Maintenance

## Cleaning the Spa Surface

To properly clean the acrylic surface, it is recommended to wipe the surface with a soft damp cloth or sponge using a mild household soap or liquid detergent. Stubborn dirt or stains may be removed by using Spic & Span which adequately dissolves in water. **DO NOT USE** any cleaning products containing abrasives or solvents. This could dull or permanently damage the brilliant surface.

## Maintaining the Wood Skirt

With time and exposure to the elements, the wood on your spa will tend to lose its new appearance. Protecting or reviving the wood surface is a fairly simple process. Lightly sanding with a fine grit sandpaper will help smooth any roughness, regular applications of a penetrating wood preservative will enhance and protect the richness of the wood.

## Maintaining The Synthetic Cabinet

Your new spa synthetic wood cabinet requires little or no maintenance of any kind. To clean, simply wipe cabinet with a clean towel and mild soap solution.

## Use and Maintenance of the Spa Cover

Using the insulated cover while the spa is not in use will tend to reduce your operating costs, heat up time, and maintenance requirements. To prolong the life of the cover, handle it with care and clean it regularly using a mild soap and water. Periodic treatments with a leather / vinyl conditioner will help protect it against deterioration caused by ultra violet rays from the sun. **Never allow anyone to stand or sit on the cover and avoid dragging it across the ground or any rough surfaces.**

## Draining the Spa

Every 1-3 months, depending upon your spa usage, you may find that the chemicals no longer effectively balance the water. At this point, draining the spa is necessary. The following procedure must be followed:

1. To drain the spa, turn off the spa circuit breaker at the main electrical panel.
2. Connect a garden hose to the drain valve of the spa, open valve and drain the spa.
3. After draining the spa, clean the spa shell, suction cover, skimmer, and filter. Close the drain valve. Refill the spa with fresh water. Check the pH level and maintain water quality.

## Return to “Start Up Steps” for Refilling Procedures

## Maintaining the Pillows

Remove and clean the pillow regularly with soapy water using a cloth or soft-bristle brush. Always remove the pillows when adding chemical shock treatment to the spa water. The pillow can be returned to the spa when the sanitizer reading drops below 3•5ppm on your water strip.

**Important:** When removing pillows equipped with suction cups, always slide them upwards until the suction cups release from the spa surface. Never pull the pillows straight out from the spa as this likely cause the suction cups permanently separate from the pillow. Pillow damage or deterioration caused by improper care is not covered under the manufacturer’s warranty.

## Water Quality Maintenance

Maintaining the quality of the water within specific limits will serve to enhance your enjoyment and prolong the life of the spa's equipment. It is a fairly simple task, but it requires regular attention because the water chemistry involved is a balance of several factors. There is not a simple formula and there is no avoiding it. A careless attitude in regard to water maintenance will result in poor conditions for soaking and even damage to your investment.

**pH** is a measure of relative acidity or alkalinity of water and is measured on a scale of 0 to 14. The midpoint of 7.0 is said to be neutral, above which is alkaline and below which is acid. In spa water, it is very important to maintain a slightly alkaline pH condition of 7.2 to 7.8 and total water alkalinity should be 80•120 ppm. Problems become proportionately more severe as the pH moves beyond the ideal range. That is the reason almost all spa water test kits contain a method to measure for pH as well as the use of a sanitizer. Failure to maintain a proper pH level will cause damage to your spa and void your warranty.

**Warning:** Spas equipped with an ozone generator, DO NOT use any polymer based product, clarifier or "perfect pH" in your spa. The ozone generated by the ozonator will break down the polymers in these products causing cloudy water. To destroy bacteria and organic compounds in the spa water, a sanitizer must be used regularly. A residual "Bromine" level of 3•5 ppm is considered desirable and can be maintained by regulating the number of bromine tablets in a floating brominator and the filtration cycles. If your spa is equipped with an ozonator, the residual bromine level may be reduced to 2•3 ppm.

**Important:** Do not use chlorine tablets (Trichlor). They may permanently damage the acrylic surface and this damage is not covered by warranty. Consult your local pool and spa supply company for advice on spa care chemicals and additives.

Many other additives are available for your spa. Some are necessary to compensate for out-of-balance water conditions and others simply make the water feel or smell better. Always consult with your local chemical supply company before using any new chemicals, as they may have a reaction with chemicals that you are using.

**Note:** Do not use soft water. This may damage the components of the spa and may void the warranty.

# Spa Troubleshooting

<b><u>PROBLEM</u></b>	<b><u>Possible solution</u></b>
<b><u>Control System Problems</u></b>	<b>See Error Messages</b>
<b><u>Spa Does Not Operate</u></b>	GFCI in supply circuit tripped No voltage in power supply circuit High Temperature – Hi limit displayed on the topside One of the fuses burned out
<b><u>Water Not Heating</u></b>	Heater not energized adjust thermostat setting to a higher setting
<b><u>Low Temperature</u></b>	Spa not covered Ambient temperature too low (below freezing) Pressure switch malfunction Filter or filter line clogged Pressure switch wires possibly loose (“PS1”). Spa in “Eco” mode Water temperature sensor open (“TS”) Heat - temp. sensor opened (“HTS”) Control Circuit board malfunction Primary pump cavitating Primary pump failure
<b><u>Poor Water Flow</u></b>	Primary pump not primed
<b><u>No Water Flow</u></b>	Closed discharge line (if equipped) Closed suction valve (if equipped) Air lock in pump or water line Filter plugged (clean 1-2 times a month) Water level too low Impeller clogged or damaged Suction or discharge line partially closed or clogged Main 30 amp fuse blown Motor overheat protection tripped Jets closed (check all jets)

**NOTE:THE SKILLS AND TOOLS NECESSARY FOR THE SAFE REPAIR OF THIS SPA REQUIRE THE SERVICES & EXPERTISE OF AN AUTHORIZED SERVICE TECHNICIAN.**

**Contact: 1-866-245-3387**

**Product specifications are subject to change without notice.  
Use the installation instructions supplied with this product.**

# Spa Troubleshooting

## **PROBLEM**

## **Possible solution**

### **Motor does not start**

Disconnect switch open  
Main fuse 30 amp blown  
Thermal protect open on motor  
Locked motor shaft (frozen)  
Motor is bad may need to be replaced  
Disconnected or failing pump cord  
Improper voltage

### **Noisy pump and motor**

Air lock within pump. (Bleed system by loosening unions on pump housing till only water comes out)  
Worn motor bearing  
Valve in suction line (if equipped) partially closed  
Loose Motor mount (check mounting bolts tighten if needed)

### **Overheating problem**

Clogged filters (check & clean if needed)  
Suction line partially obstructed or plugged  
Low water level  
Partially clogged discharge line  
Excessive jet pump operation  
Ambient (outside) temperature is too high

### **Mode will not change**

Circuit board with disconnected or failing the interconnection cord

### **Abnormal water usage**

Leak in plumbing.  
Excessive evaporation and/or splashing.

**NOTE: THE SKILLS AND TOOLS NECESSARY FOR THE SAFE REPAIR OF THIS SPA REQUIRE THE SERVICES OF AN AUTHORIZED SERVICE TECHNICIAN.**

**Contact: 1-866-245-3387**

**Product specifications are subject to change without notice.  
Use the installation instructions supplied with this product.**

# GFCI WIRING INSTRUCTIONS

## IMPORTANT NOTES:

FOR INSTALLATION OF A (2) TWO-POLE GFCI-CIRCUIT BREAKER INTO A LOAD CENTER. THESE ASSEMBLIES ARE DESIGNED ESPECIALLY FOR USE BY QUALIFIED ELECTRICIANS TO MEET THE SWIMMING POOL & SPA REQUIREMENTS OF ARTICLES 680-12 & 680-42 OF THE 1996 NATIONAL ELECTRICAL CODE (NEC) 680-12. DISCONNECTING MEANS SHALL BE ACCESSIBLE, LOCATED WITHIN SIGHT OF POOL, SPA EQUIPMENT, AND SHALL BE LOCATED AT LEAST (5) FIVE FEET HORIZONTALLY FROM INSIDE WALLS OF THE POOL, SPA OR HOT TUB. NATIONAL ELECTRIC CODE (NEC) 682-42. PROTECTION OF AN OUTLET THAT SUPPLIES A SELF CONTAINED SPA OR HOT TUB EQUIPMENT ASSEMBLY, ALL SPA EQUIPMENT SHALL BE PROTECTED BY A (GFCI) GROUND-FAULT CIRCUIT INTERRUPTER. TO ENSURE THAT PEOPLE IN THE SPA ARE PROTECTED.

INSTALLATION OF THE GFCI CIRCUIT BREAKER, INCLUDING AMP SIZING AND SELECTION OF CONDUCTOR SIZE & TYPE, MUST BE INSTALLED BY A QUALIFIED ELECTRICIAN, IN ACCORDANCE WITH THE NATIONAL ELECTRICAL CODE (NEC), OWNERS MANUAL, AND ALL FEDERAL, STATE AND LOCAL CODES AND REGULATIONS IN EFFECT AT THE TIME OF INSTALLATION. A LOAD NEUTRAL CONNECTION IS REQUIRED, BECAUSE SPAS CONTAIN BOTH 115 AND 240 VOLT EQUIPMENT. THE GFCI LINE NEUTRAL WIRE (PIGTAIL) MUST BE CONNECTED IN ALL INSTALLATIONS. THE GFCI WILL NOT OPERATE CORRECTLY WITHOUT CONNECTION OF LINE NEUTRAL WIRE TO AN INCOMING LINE NEUTRAL.

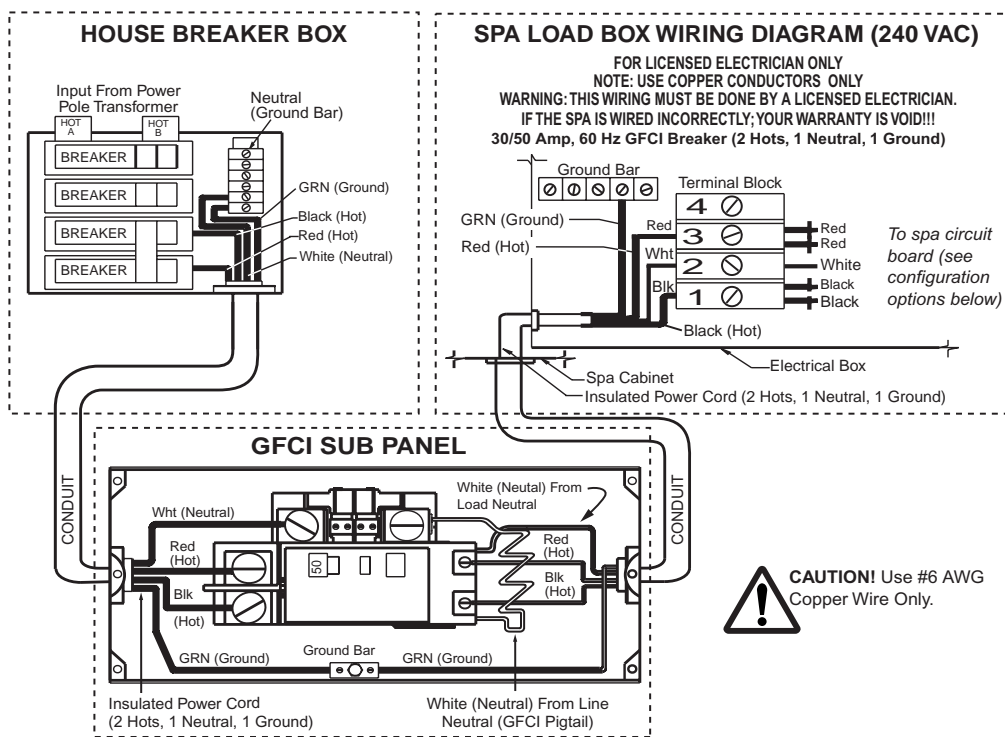

## CIRCUIT BOARD CONFIGURATION OPTIONS

All Model 62, Model 65, and Monarch spas are factory configured for a 240 VAC 50 amp service. In this configuration, the heater **will operate** while both jet pumps are running. An alternate 30 amp service can be configured for locations where 50 amp service is unavailable. In this configuration, the heater **will not operate** while both jet pumps are running. To configure spa for 30 amp service, place a jumper across the circuit board's JP2 jumper position #8 as shown (right).

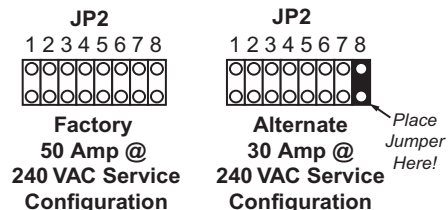

**NOTE: THE SKILLS AND TOOLS NECESSARY FOR THE SAFE REPAIR OF THIS SPA REQUIRE THE SERVICES OF AN AUTHORIZED SERVICE TECHNICIAN.**

Contact: 1-866-245-3387

# WIRING DIAGRAM FOR 120VAC / 240VAC CONVERTIBLE SYSTEM

USE COPPER CONDUCTORS ONLY

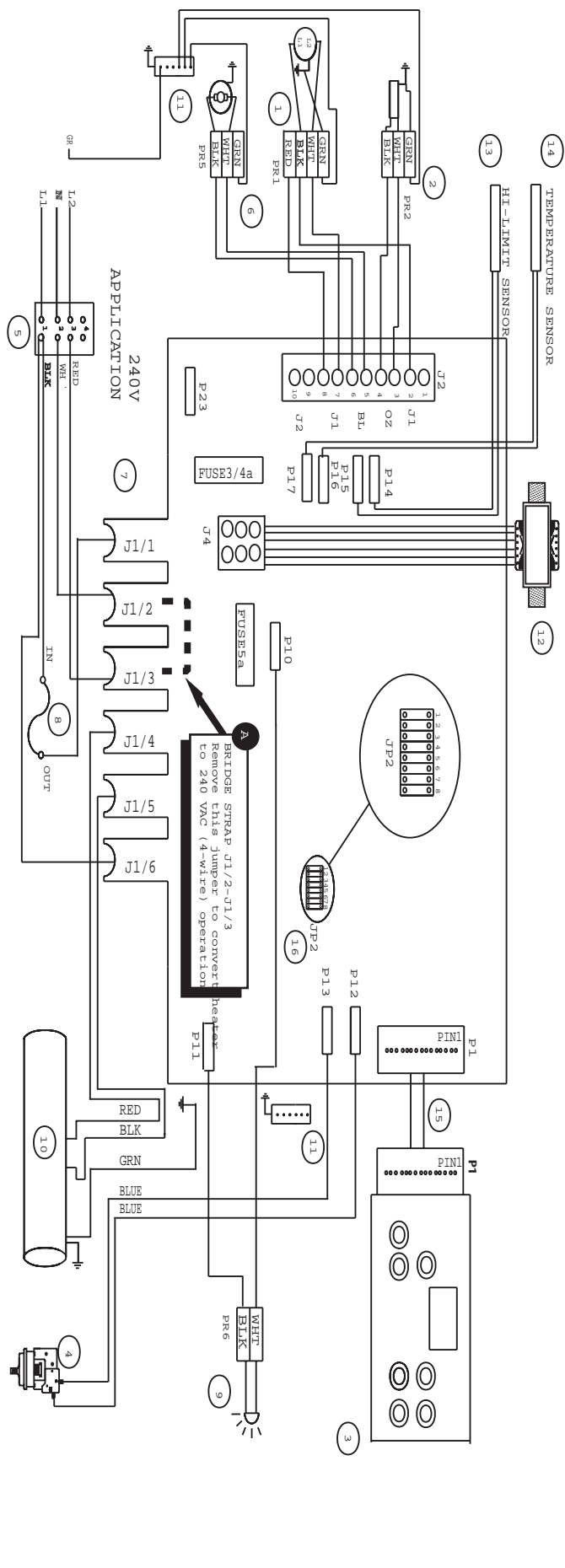

NOTE: IF UNIT IS TO BE PERMANENTLY CONNECTED, CONNECT ONLY TO A CIRCUIT PROTECTED BY A GROUND FAULT CIRCUIT INTERRUPTER (GFCI).

- 1) 2 SPEED PUMP
- 2) OZONATOR \*
- 3) TOPSIDE CONTROL
- 4) PRESSURE SWITCH
- 5) SUPPLY TERMINAL BLOCK
- 6) BLOWER \*
- 7) CONTROL BOARD
- 8) FUSE 30 AMP.
- 9) SPA LIGHT
- 10) HEATER
- 11) GROUND BARS
- 12) TRANSFORMER W/ WIRES & PLUG
- 13) HI-LIMIT SENSOR
- 14) TEMPERATURE SENSOR
- 15) TOPSIDE CONTROL CABLE
- 16) MODE SELECT (JUMPERS) \* IF EQUIPPED

**CONVERSION INSTRUCTION 120 VAC TO 240 VAC**

- 1) DISCONNECT FROM POWER AND REMOVE CORD 12/3 OR 14/3.
- 2) REMOVE JUMPER STRIP J1/2-J1/3 ON THE CONTROL BOARD (SEE WIRE DIAGRAM).
- 3) REMOVE THE HEATER MODE SELECTOR JUMPER JP2/8 ON CONTROL BOARD (SEE WIRE DIAGRAM).
- 4) CONNECT THE GROUND WIRE OF THE 6/3 + GROUND CABLE TO GROUND BAR.
- 5) CONNECT LINE 1 WIRE TO TERMINAL 1 OF THE SUPPLY TERMINAL BLOCK.
- 6) CONNECT LINE 2 WIRE TO TERMINAL 3 OF THE SUPPLY TERMINAL BLOCK.
- 7) CONNECT THE LOAD NEUTRAL WIRE FROM LOAD NEUTRAL ON GFCI TO TERMINAL 2 OF THE SUPPLY TERMINAL BLOCK.

